



Features

- Formerly *J.W. Miller* model
- Current rating up to 3.3 A
- Dielectric strength of 500 Vrms
- Tape and reel packaging
- RoHS compliant*

Applications

- Parallel, series, dual differential mode inductor and 1:1 ratio transformer

PM3602 Series - SMD Inductor/Transformer

Electrical Specifications

Bourns Part No.	PARALLEL				SERIES			
	Inductance (μH) ±20 %	I _{rms} (A)	Inductance (μH) ±20 % @ I _{rms}	DCR (Ω) max.	Inductance (μH) ±20 %	I _{rms} (A)	Inductance (μH) ±20 % @ I _{rms}	DCR (Ω) max.
PM3602-5-RC	5	2.41	3.8	0.023	20	1.20	15.2	0.092
PM3602-8-RC	8	1.90	6.1	0.037	32	0.95	23.2	0.15
PM3602-10-RC	10	1.83	7.4	0.040	40	0.92	29.6	0.16
PM3602-15-RC	15	1.45	11.1	0.063	60	0.73	44.4	0.25
PM3602-20-RC	20	1.25	15.2	0.086	80	0.63	60.8	0.34
PM3602-25-RC	25	1.17	18.5	0.098	100	0.59	74	0.39
PM3602-33-RC	33	0.98	24.8	0.14	132	0.49	99.2	0.56
PM3602-50-RC	50	0.78	37.5	0.22	200	0.38	150	0.88
PM3602-68-RC	68	0.72	49.6	0.26	272	0.36	198.4	1.04
PM3602-100-RC	100	0.58	74.0	0.40	400	0.29	296	1.60
PM3602-150-RC	150	0.47	111.0	0.60	600	0.24	444	2.40
PM3602-200-RC	200	0.40	150.0	0.84	800	0.20	600	3.36
PM3602-250-RC	250	0.33	192.5	1.19	1000	0.17	770	4.76
PM3602-300-RC	300	0.32	225.0	1.31	1200	0.16	900	5.24
PM3604-5-RC	5	3.30	3.8	0.019	20	1.65	15.2	0.076
PM3604-8-RC	8	3.00	5.8	0.024	32	1.50	23.2	0.096
PM3604-10-RC	10	2.70	7.3	0.028	40	1.35	29.2	0.11
PM3604-15-RC	15	2.20	11.0	0.041	60	1.10	44	0.16
PM3604-20-RC	20	2.02	14.2	0.049	80	1.01	56.8	0.20
PM3604-25-RC	25	1.91	17.0	0.054	100	0.96	68	0.22
PM3604-33-RC	33	1.60	23.1	0.078	132	0.80	92.4	0.31
PM3604-50-RC	50	1.28	35.5	0.12	200	0.64	142	0.48
PM3604-68-RC	68	1.19	46.2	0.14	272	0.60	184.8	0.56
PM3604-100-RC	100	0.98	68.0	0.21	400	0.49	272	0.84
PM3604-150-RC	150	0.78	103.5	0.32	600	0.39	414	1.28
PM3604-200-RC	200	0.65	140.0	0.47	800	0.33	560	1.88
PM3604-250-RC	250	0.60	172.5	0.53	1000	0.30	690	2.12
PM3604-300-RC	300	0.52	213.0	0.73	1200	0.26	852	2.92

General Specifications

Temperature Rise35 °C max. at I_{rms}
 Operating Temperature ...-55 °C to +125 °C
 Storage Temperature.....-55 °C to +125 °C
 Soldering.....245 °C, 5 seconds max.
 Dielectric Strength.....500 Vrms between windings

Materials

CoreIron
 WirePolyurethane-coated copper
 Terminal CoatingSn-Ag-Cu alloy
 Packaging
 PM3602700 pcs. per 13-inch reel
 PM3604400 pcs. per 13-inch reel

Product Dimensions

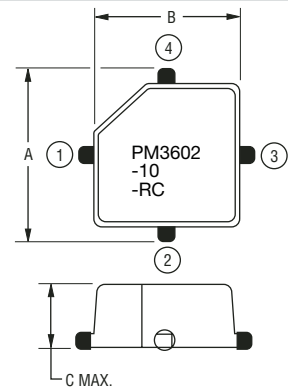

Model	A	B	C
PM3602	$\frac{11.48}{(0.452)}$	$\frac{8.99}{(0.354)}$	$\frac{5.72}{(0.225)}$
PM3604	$\frac{13.97}{(0.550)}$	$\frac{11.48}{(0.452)}$	$\frac{6.73}{(0.265)}$

Schematics

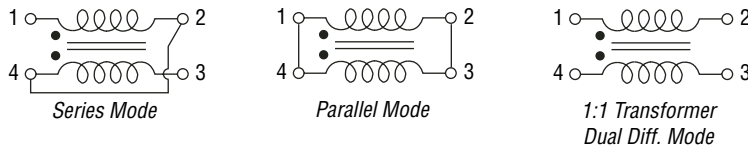

Recommended Pad Layout

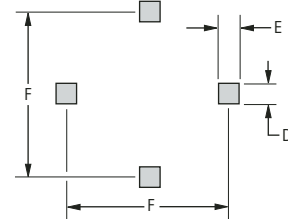

Model	D	E	F
PM3602	$\frac{2.54}{(0.10)}$	$\frac{2.54}{(0.10)}$	$\frac{9.78}{(0.285)}$
PM3604	$\frac{4.06}{(0.16)}$	$\frac{2.54}{(0.10)}$	$\frac{12.7}{(0.500)}$

DIMENSIONS: $\frac{\text{MM}}{\text{(INCHES)}}$

*RoHS Directive 2002/95/EC Jan 27 2003 including Annex
 Specifications are subject to change without notice.
 Customers should verify actual device performance in their specific applications.

PM3600 Series - SMD Inductor/Transformer

BOURNS®

Packaging Specifications

PM3602

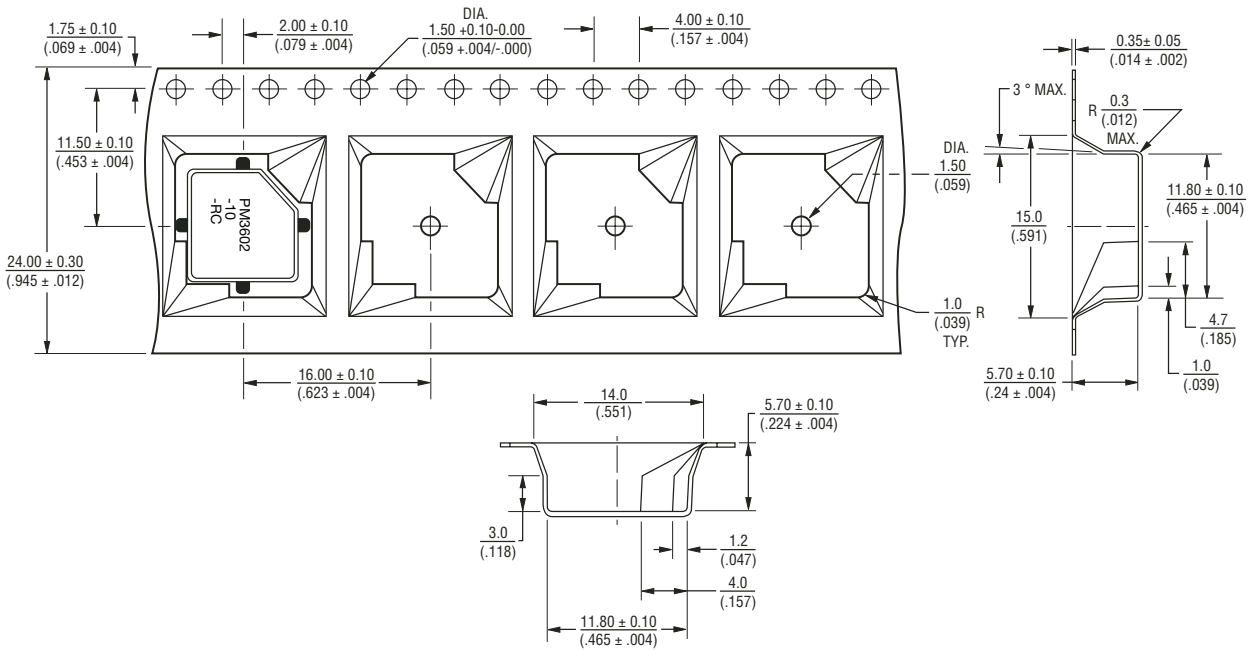

PM3604

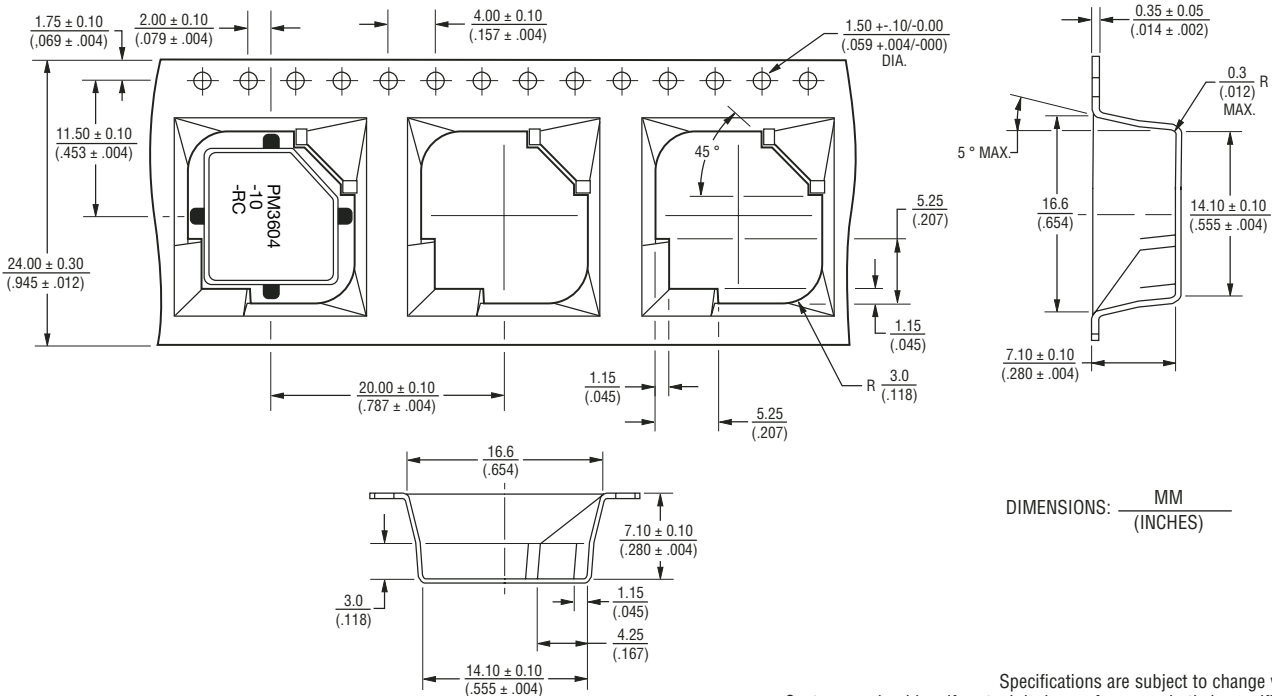

DIMENSIONS: $\frac{\text{MM}}{\text{(INCHES)}}$

Specifications are subject to change without notice. Customers should verify actual device performance in their specific applications.

PM3600 Series - SMD Inductor/Transformer

BOURNS®

Packaging Specifications (Continued)

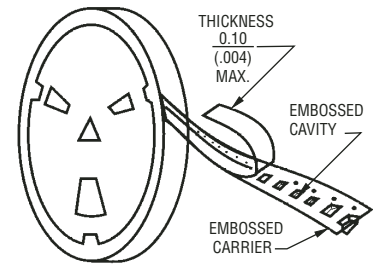
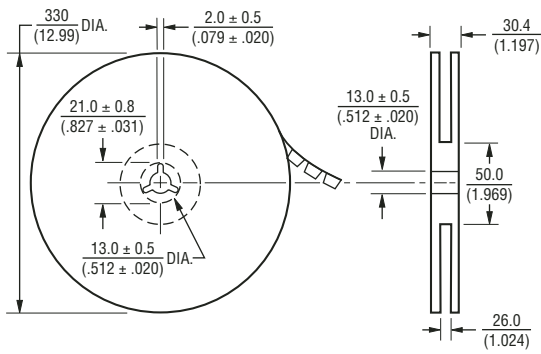

DIMENSIONS: $\frac{\text{MM}}{\text{(INCHES)}}$

REV. 07/08

Specifications are subject to change without notice.
Customers should verify actual device performance in their specific applications.